

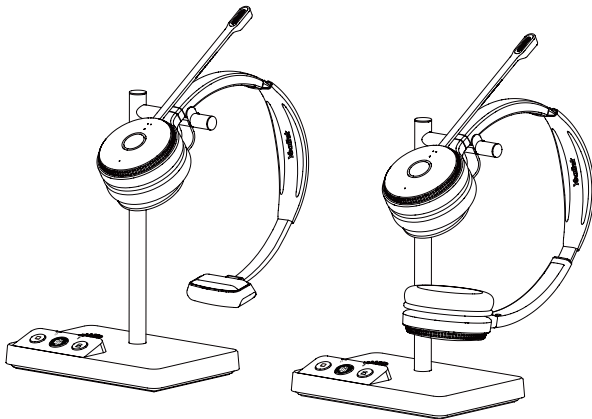

WHB620, WHD622, WHM621 DECT Wireless Headset

Quick Start Guide



Package List

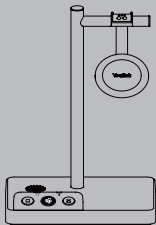

WHB620 Base (Teams/UC)

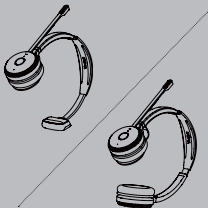

WHM621/WHD622 Headset



Micro USB to USB-A
USB2.0 Cable 0.8M



Micro USB to USB-A
USB2.0 Cable 1.2M



Quick Start Guide



Busylight BLT60
(Optional)



We recommend that you use the included accessories, and other accessories may have compatibility issues that prevent them from working properly.

How to Connect

Busylight BLT60

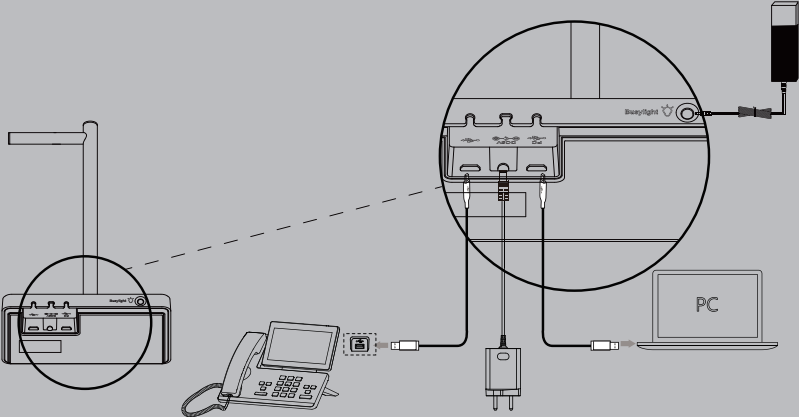

Headset Wear and Adjustment

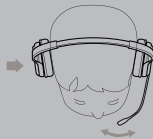
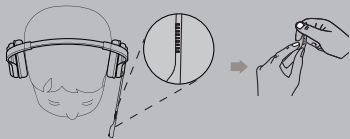

Earmuff Replacement

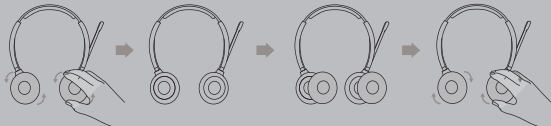

How to Use

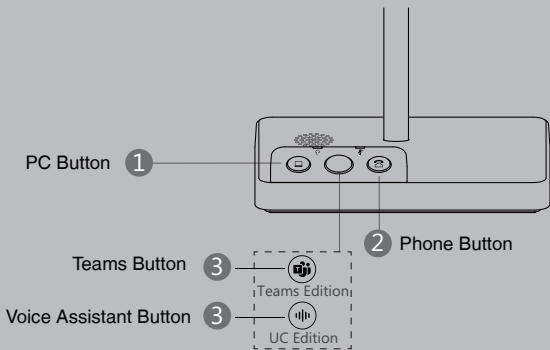

- ① Press to enter the softphone dialing screen, answer or enter a softphone's call.
- ② Press to enter the phone dialing screen, answer or end a phone's call.
- ③ (Teams Edition) Press to invoke the Teams client; Hold 2 seconds to activate Cortana.
(UC Edition) Hold 2 seconds to activate voice assistant.



Before using the Teams button functions, you should install the Microsoft Teams client on your PC, smartphone or tablet.

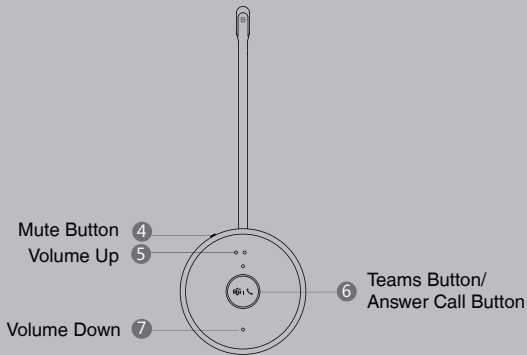

Mute Button ④

Volume Up ⑤

Volume Down ⑦

⑥ Teams Button/
Answer Call Button

④ Press to mute or unmute microphone.

⑤ ⑦ Hold 2 seconds to activate Cortana; Press to turn up/down volume.

⑥ Press to answer, reject, or end a call.

Regulatory Notices

Operating Ambient Temperatures

- Operating temperature: +14 to 122°F (-10 to 50°C)
- Relative humidity: 5% to 90%, noncondensing
- Storage temperature: -22 to +160°F (-30 to +70°C)

Warranty

Our product warranty is limited only to the unit itself, when used normally in accordance with the operating instructions and the system environment. We are not liable for damage or loss resulting from the use of this product, or for any claim from a third party. We are not liable for problems with Yealink device arising from the use of this product; we are not liable for financial damages, lost profits, claims from third parties, etc., arising from the use of this product.

DC symbol

 is the DC voltage symbol.

Restriction of Hazardous Substances Directive (RoHS)

This device complies with the requirements of the EU RoHS Directive. Statements of compliance can be obtained by contacting support@yealink.com.

Safety Instructions

Save these instructions. Read these safety instructions before use!

The following basic safety precautions should always be followed to reduce risk of fire, electrical shock, and other personal injury.



General Requirements

- Before you install and use the device, read the safety instructions carefully and observe the situation during operation.
- During the process of storage, transportation, and operation, please always keep the device dry and clean.
- During the process of storage, transportation, and operation, please avoid collision and crash of the device.
- Please attempt not to dismantle the device by yourself. In case of any discrepancy, please contact the appointed maintenance center for repair.
- Without prior written consent, no organization or individual is permitted to make any change to the structure or the safety design of the device. Yealink is under no circumstance liable to consequences or legal issues caused by such changes.
- Please refer to the relevant laws and statutes while using the device. Legal rights of others should be respected as well.



Environmental Requirements

- Place the device at a well-ventilated place. Do not expose the device under direct sunlight.
- Keep the device dry and free of dusts.
- Place the device on a stable and level platform.
- Please place no heavy objects on the device in case of damage and deformation caused by the heavy load.
- Keep at least 10 cm between the device and the closest object for heat dissipation.
- Do not place the device on or near any inflammable or fire-vulnerable object, such as rubber-made materials.
- Keep the device away from any heat source or bare fire, such as a candle or an electric heater.
- Keep the device away from any household appliance with strong magnetic field or electromagnetic field, such as a microwave oven or a refrigerator.



Operating Requirements

- Do not let a child operate the device without guidance.
- Do not let a child play with the device or any accessory in case of accidental swallowing.
- Please use the accessories provided or authorized by the manufacturer only.
- The power supply of the device shall meet the requirements of the input voltage of the device. Please use the provided surge protection power socket only.
- Before plugging or unplugging any cable, make sure that your hands are completely dry.
- Do not spill liquid of any kind on the product or use the equipment near water, for example, near a bathtub, washbowl, kitchen sink, wet basement or near a swimming pool.

- Do not tread on, pull, or over-bend any cable in case of malfunction of the device.
- During a thunderstorm, stop using the device and disconnect it from the power supply. Unplug the power plug and the Asymmetric Digital Subscriber Line (ADSL) twisted pair (the radio frequency cable) to avoid lightning strike.
- If the device is left unused for a rather long time, disconnect it from the power supply and unplug the power plug.
- When there is smoke emitted from the device, or some abnormal noise or smell, disconnect the device from the power supply, and unplug the power plug immediately. Contact the specified maintenance center for repair.
- Do not insert any object into equipment slots that is not part of the product or auxiliary product.
- Before connecting a cable, connect the grounding cable of the device first. Do not disconnect the grounding cable until you disconnect all other cables.



Cleaning Requirements

- Before cleaning the device, stop using it and disconnect it from the power supply.
- Use a piece of soft, dry and anti-static cloth to clean the device.
- Keep the power plug clean and dry. Using a dirty or wet power plug may lead to electric shock or other perils.



ENVIRONMENTAL RECYCLING

Never dispose of the device with domestic waste



Ask your Town Council about how to dispose of it in an environmentally friendly way. The cardboard box, plastic packaging and player components may be recycled in accordance with prevailing recycling regulations in your country.

Always adhere to prevailing regulations

Those who fail to do so may be fined or prosecuted in accordance with the law. The crossed out garbage can that appears on the device means that when it has reached the end of its useful life, it should be taken to a special waste disposal centre and treated separately to general urban waste.



Troubleshooting

The unit cannot supply power to Yealink device.
There is a bad connection with the plug.

1. Clean the plug with a dry cloth.
 2. Connect it to another wall outlet.
- The usage environment is out of operating temperature range.
1. Use in the operating temperature range.
- The cable between the unit and the Yealink device is connected incorrectly.
1. Connect the cable correctly.
- You cannot connect the cable properly.
1. You may have connected a wrong Yealink device.
 2. Use the correct power supply.
- Some dust, etc., may be in the port.
1. Clean the port.
- Contact your dealer or authorized service facility for any further questions.

Contact Information

YEALINK NETWORK TECHNOLOGY CO.,LTD.

309, 3rd Floor, No.16, Yun Ding North Road, Huli District, Xiamen City, Fujian, P.R.C

YEALINK (EUROPE) NETWORK TECHNOLOGY B.V.

Strawinskylaan 3127, Atrium Building, 8th floor, 1077ZX Amsterdam, The Netherlands

YEALINK (USA) NETWORK TECHNOLOGY CO., LTD.

999 Peachtree Street Suite 2300, Fulton, Atlanta, GA, 30309, USA

Made in China

FCC Caution:

Any Changes or modifications not expressly approved by the party responsible for compliance could void the user's authority to operate the equipment.

This device complies with part 15 of the FCC Rules. Operation is subject to the following two conditions: (1) This device may not cause harmful interference, and (2) this device must accept any interference received, including interference that may cause undesired operation.

IMPORTANT NOTE:

Note: This equipment has been tested and found to comply with the limits for a Class B digital device, pursuant to part 15 of the FCC Rules. These limits are designed to provide reasonable protection against harmful interference in a residential installation. This equipment generates, uses and can radiate radio frequency energy and, if not installed and used in accordance with the instructions, may cause harmful interference to radio communications. However, there is no guarantee that interference will not occur in a particular installation. If this equipment does cause harmful interference to radio or television reception, which can be determined by turning the equipment off and on, the user is encouraged to try to correct the interference by one or more of the following measures:

- Reorient or relocate the receiving antenna.
- Increase the separation between the equipment and receiver.
- Connect the equipment into an outlet on a circuit different from that to which the receiver is connected.
- Consult the dealer or an experienced radio/TV technician for help.

ISED/C Warning

This device complies with Innovation, Science, and Economic Development Canada licence-exempt RSS standard(s). Operation is subject to the following two conditions:

- (1) this device may not cause interference, and
- (2) this device must accept any interference, including interference that may cause undesired operation of the device.

Le présent appareil est conforme aux CNR d'Innovation, Sciences et Développement économique Canada applicables aux appareils radio exempts de licence. L'exploitation est autorisée aux deux conditions suivantes :

- (1) l'appareil ne doit pas produire de brouillage, et
- (2) l'utilisateur de l'appareil doit accepter tout brouillage radioélectrique subi, même si le brouillage est susceptible d'en

compromettre le fonctionnement.

Radiation Exposure Statement

For Base: This equipment complies with FCC and IC radiation exposure limits set forth for an uncontrolled environment. This equipment should be installed and operated with minimum distance 20cm between the radiator and your body.

Cet émetteur ne doit pas être Co-placé ou ne fonctionnant en même temps qu'aucune autre antenne ou émetteur. Cet équipement devrait être installé et actionné avec une distance minimum de 20 centimètres entre le radiateur et votre corps. For Headset :The device has been tested and comply with FCC and IC SAR limits. L'appareil a été testé et est conforme aux restrictions FCC et IC SAR.